



Specification Sheet

Product - Gair, GAIR02

Product Range - Cityscape

Product Dimensions (Dia x H) - 750 x 750 mm

Product Description - Professional grade commercial landscape plant container

Product Material - Handmade Fibreglass Composite and Strengthening Materials

Product Durability - High UV resistance, 100% frost resistant, highly robust body

Product Drainage - Naturally waterproof, drainage holes can be drilled in the base or sides as required

Product Finish - Huge range including any colour paint or robust marine grade textured finishes, concrete, earthenware, stone and metals including ready rusted Corten and Copper based Verdigris. See specific finish sheet for properties, options and full care details

Product Sustainability - Excellent. Low carbon footprint, Fully refinishable to as new quality, very long life, Approved material and product for COP26 Glasgow.



Product Dimensions (mm)

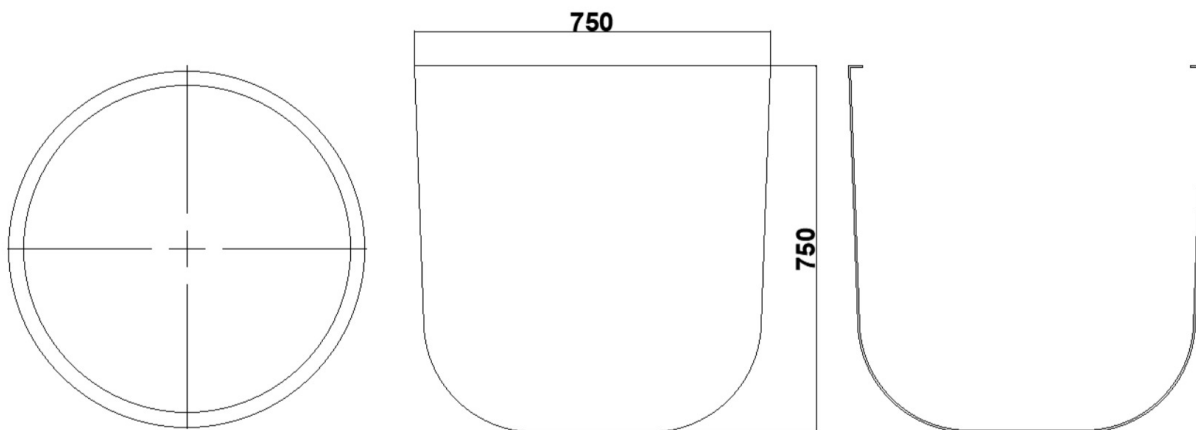

Important Notes

- All packaging material should be removed from the product on delivery. Some of our specialist finishes can be damaged by even short-term contact with wet packaging.
- Always drill drainage hole in the base of any planter to be used outdoors. For best results fit a Tanker irrigation system to control watering and prolong the watering interval.
- All standard and bespoke products must be installed on flat, level ground where the base is evenly supported. Do not raise on feet or runners of any kind. Do not move once filled. Strengthened bases, feet, castors and pallet bases can all be specified for an extra charge where appropriate.
- Planters must be filled with retail or commercial grade composts only. Filling with graded topsoil, hardcore or worse will invalidate the warranty.
- Please see the appropriate finish specification sheet for your planter for full care and repair instructions.
- All planters have a 5-year repair or replace warranty. See our terms and conditions of trade for full information.



Scan to view product online